

INSERTION fitting for flow measurement or analysis

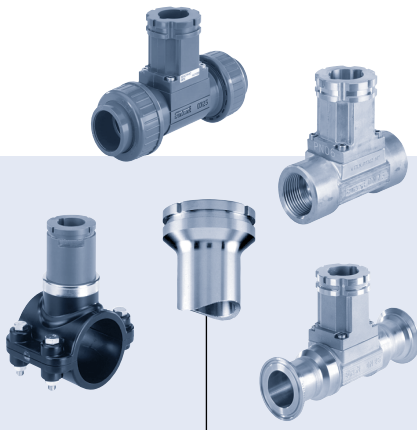

Type S020 can be combined with...



Type 8020
Flow sensor

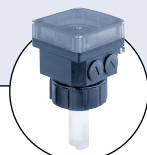

Type 8024
Flow indicator

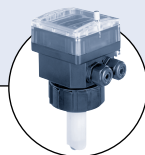

Type 8025
Digital flow transmitter

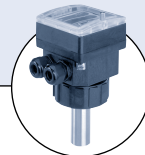

Type 8045/8041
Electromagnetic flow transmitter

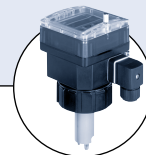

Type 8205/8206
Digital pH/ ORP transmitter

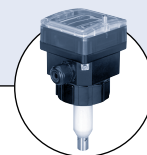

Type 8225
Digital conductivity transmitter

- Universal fitting for INSERTION sensors, transmitters, batch controllers in pure, aggressive or contaminated liquids
- Large range of process connections: in PVC, PP, PVDF, PE, stainless steel, brass
- Pipe diameter 1/4" – 16"
- Electronics available for
 - Indication, Monitoring, Transmitting
 - On/Off control, Batch control

The fitting can be used to connect any INSERTION device for a measurement in the pipe– i.e. sensors, indicators, transmitters and controllers for flow, pH, ORP and conductivity measurement.

General data

Pipe diameter	1/4" up to 16" (DN 06 up to DN 400) ¹⁾
Fitting port connection	
Metal	Internal or external thread, weld ends, clamp, ANSI flange
Plastic	True union, spigot and external thread
Materials	
Seal	FKM or EPDM
Body & adaptation part	Brass (CuZn39Pb2) & stainless steel (316L -1.4404), all stainless steel (316L -1.4404) or all PVC, PP, PVDF, PE

Medium data

Fluid temperature (320°F max.)	Temperature limits may depend on the sensor. Please refer to appropriate instruction manual or datasheet for more details.
Fluid pressure (max.)	
Metal	232 PSI (PN 16)
Plastic	145 PSI (PN 10)
	Pressure limits may depend on the sensor. Please refer to appropriate instruction manual or datasheet for more details.

Environment - Approvals

Ambient temperature	Temperature limits may depend on the sensor. Please refer to appropriate instruction manual or datasheet for more details.
Approval / Certificate on request	3.1 Certificate; 2.2 Certificate; Rugosity Certificate; FDA (with EPDM seal) - stainless steel fitting only

¹⁾ Combination between fitting and sensors is sometimes restricted to some DN (see diagram: combining the S020 with sensors on next page)

Combining the S020 with sensors for flow rate, pH or redox, conductivity measurement

Available fitting PSI (DN)	T-fitting S020	1/4" (DN 6) 2 1/2" (DN65)
	Welding tab S020	2" (DN50) 8" (DN200) 14" (DN350)
	Fusion spigot S020	2 1/2" (DN65) 4" (DN100) 16" (DN400)
	Screw-on S020	4" (DN100) 16" (DN400)
	PVC saddle 1501	2 1/2" (DN65) 4" (DN100) 8" (DN200)
Carbon steel saddle 1501		2" (DN50) 14" (DN350)
Flow rate measurement (Insertion) 8020 - 8024 - 8025 - 8041 - 8045		1/4" (DN 6) 4" (DN100) 8" (DN200) 16" (DN400)
pH or Redox measurement 8200 - 8205 - 8206 compact version or remote version		1/2" (DN15) 8" (DN200)
Conductivity measurement 8220 - 8223 - 8225 -8226		1/2" (DN15) 1 1/4" (DN32) 8" (DN200)

Note A: For true union connection ISO, analysis version only.
 Note B: Minimum size for U.S. ANSI version is 1 1/4" (DN 32)

Pressure / temperature chart

Fittings with

- Type 8020 - 8024 - 8025 flow sensor/transmitter
- Type 8220 - 8225 analyse sensor/transmitter

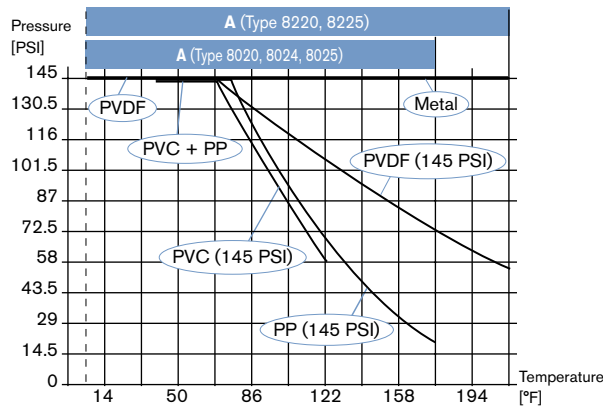

Fittings with

- Type 8041 - 8045 PVDF flow sensor/transmitter
- Type 8205 - 8206 - 8223 - 8226 analyse sensor/transmitter

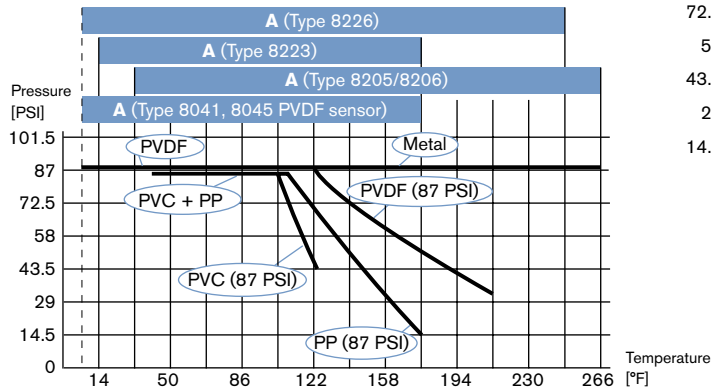

Pressure and temperature limits depend on the sensor. Please refer to corresponding sensor datasheet for more details.

Fittings with

- Type 8041 - 8045 stainless steel flow sensor/transmitter

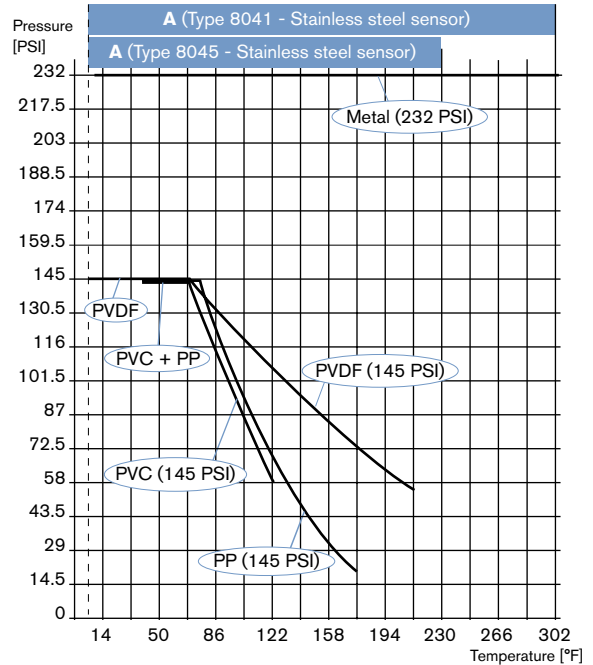

Selection fitting / pipe size

Example:

- Specification of nominal flow: 50 gpm
- Ideal flow velocity: 6 – 8 f/s
- For these specifications, the diagram indicates a pipe size of 1 1/2" (DN40) [or 2" (DN50) for (*) mentioned fittings]

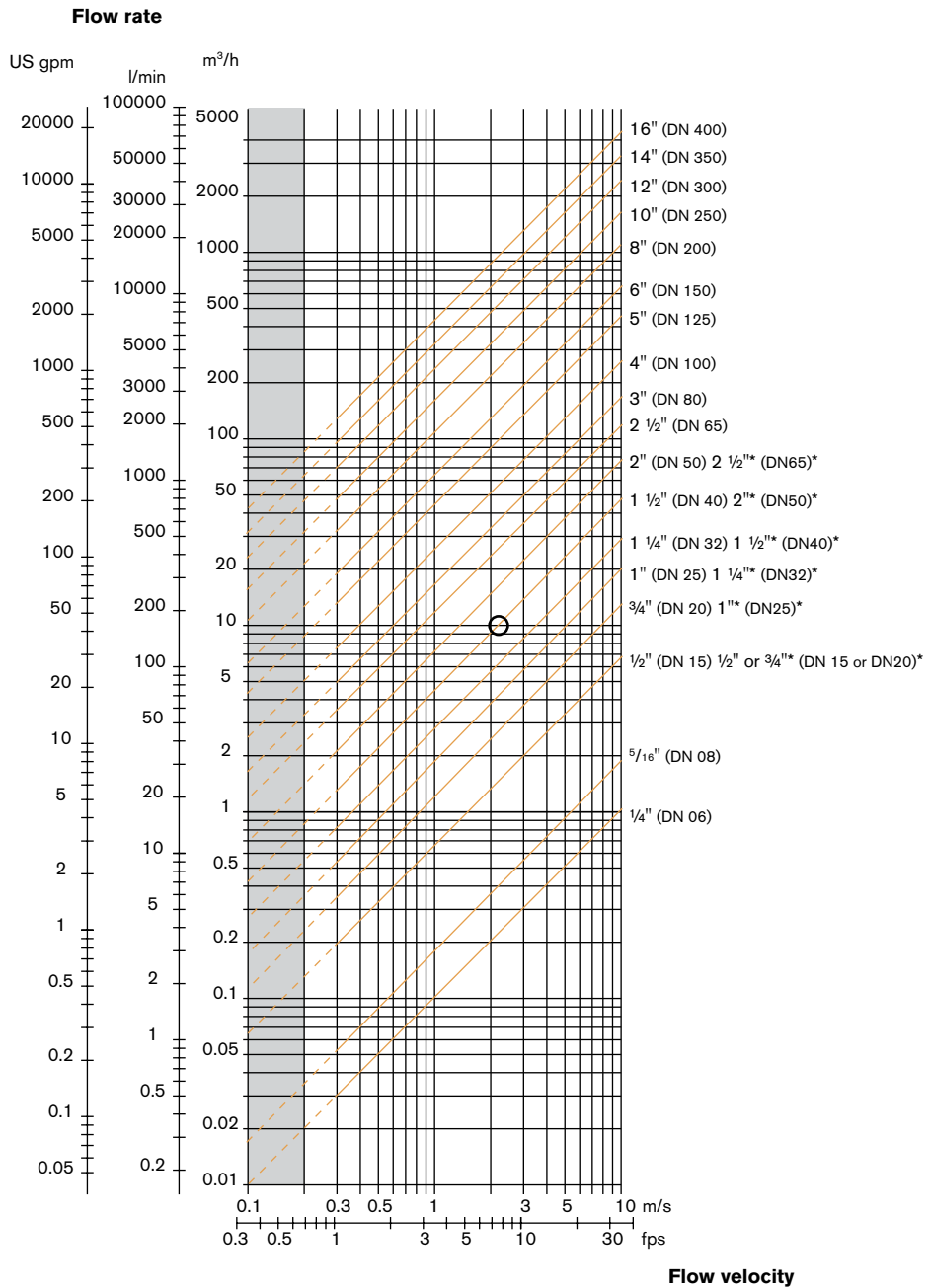

* For following fittings:
 - with external threads acc. to SMS 1145
 - with weld-ends acc. to SMS 3008, BS 4825 / ASME BPE or DIN 11850 Series 2
 - clamp acc. to SMS 3017 / ISO 2852, BS 4825 / ASME BPE or DIN 32676

Installation

Flow measurement:

Minimum straight upstream and downstream distances must be observed. According to the pipe's design, necessary distances can be bigger or use a flow conditioner to obtain the best accuracy. For more information, please refer to EN ISO 5167-1.

EN ISO 5167-1 prescribes the straight inlet and outlet distances that must be complied with when installing fittings in pipe lines in order to achieve calm flow conditions. The most important layouts that could lead to turbulence in the flow are shown below, together with the associated prescribed minimum inlet and outlet distances. These ensure calm, problem-free measurement conditions at the measurement point.

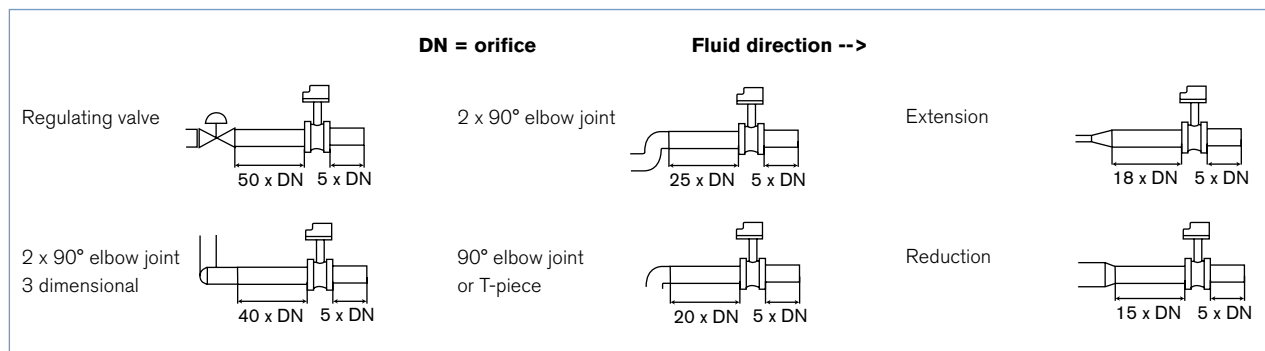

The flow rate sensor can be installed in either horizontal or vertical pipes.

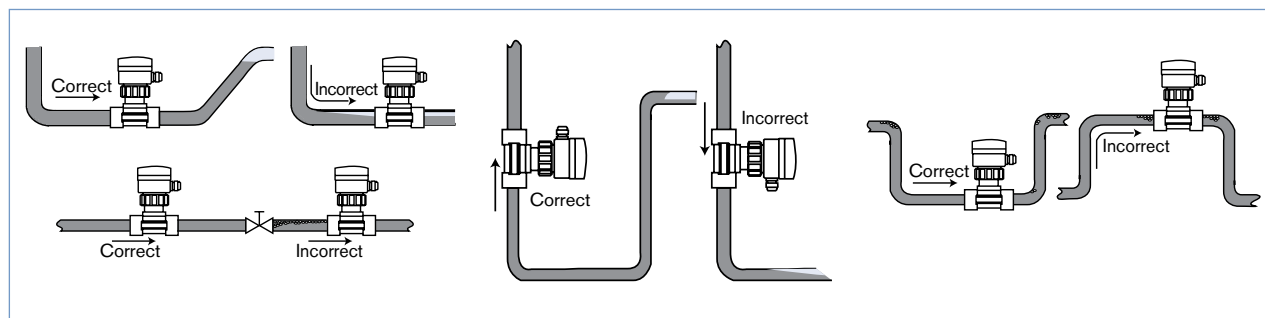

Analysis measurement:

For pH and ORP measurements, we recommended a "U"-form bypass installation to ensure that the electrode is maintained in a wet condition and enable the customer to calibrate the unit without stopping the whole process or to use the special designed measuring chamber. The specially designed measuring chamber enables to install all pH-, ORP-, conductivity-transmitters or electrodes in all pipe systems, either directly in the main stream or in a by-pass line. Additionally it enables to keep the electrode always wet and isolates it easily from the main stream for calibration purposes.

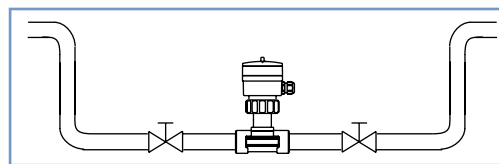

Pressure and temperature ratings must be respected according to the selected fitting material. The suitable pipe size is selected using the diagram Flow / Velocity / DN.

INSERTION fitting dimensions

Internal thread connection

G, NPT or Rc
in stainless steel (316L - 1.4404) or
brass (CuZn39Pb2)

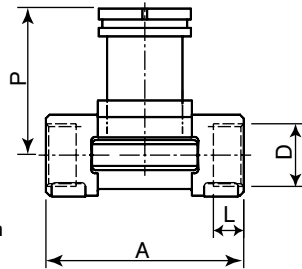

NOTE:
short sensor version

DN [mm]	P [mm]	A [mm]	D [inch]	L [mm]
15	80.3	84.0	G 1/2 NPT 1/2 Rc 1/2	16.0 17.0 15.0
20	77.8	94.0	G 3/4 NPT 3/4 Rc 3/4	17.0 18.3 16.3
25	78.0	104.0	G 1 NPT 1 Rc 1	23.5 18.0 18.0
32	81.6	119.0	G 1 1/4 NPT 1 1/4 Rc 1 1/4	23.5 21.0 21.0
40	85.4	129.0	G 1 1/2 NPT 1 1/2 Rc 1 1/2	23.5 20.0 19.0
50	91.5	148.5	G 2 NPT 2 Rc 2	27.5 24.0 24.0

External thread connection

G,
in stainless steel (316L - 1.4404),
brass (CuZn39Pb2),
PVC (only DN 6 and DN 8)

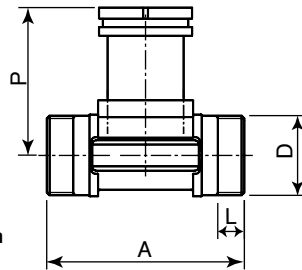

NOTE:
short sensor version

DN [mm]	P [mm]	A [mm]	D [inch]	[mm]	L [mm]
06	75.3	90.0	G 1/2	-	14.0
08	75.3	90.0	G 1/2	-	14.0
15	80.3	84.0	G 3/4	-	11.5
20	77.8	94.0	G 1	-	13.5
25	78.0	104.0	G 1 1/4	-	14.0
32	81.6	119.0	G 1 1/2	-	18.0
40	85.4	129.0	-	M 55 x 2	19.0
50	91.5	148.5	-	M 64 x 2	20.0

External thread connection

SMS 1145,
in stainless steel (316L - 1.4404)

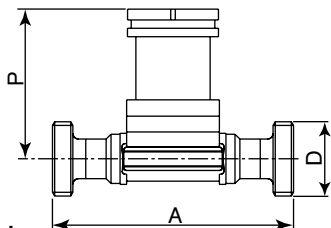

NOTE:
short sensor version

DN [mm]	P [mm]	A [mm]	D
25	77.8	130	Rd 40 x 1/6"
40	81.6	164	Rd 60 x 1/6"
50	85.4	173	Rd 70 x 1/6"

INSERTION fitting dimensions

Weld ends connection

EN ISO 1127 / ISO 4200, SMS 3008 or
BS 4825 / ASME BPE
in stainless steel (316L - 1.4404)

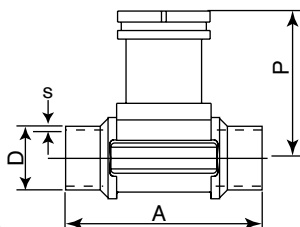

NOTE:
short sensor version

DN	P	A	Standard	D	s
[mm]	[mm]	[mm]		[mm]	[mm]
15	80.3	84.0	EN ISO 1127 / ISO 4200	21.30	1.60
	-	-	SMS 3008	-	-
	-	-	ASME BPE	-	-
20	77.8	94.0	EN ISO 1127 / ISO 4200	26.9	1.60
	-	-	SMS 3008	-	-
	83.3	84.0	ASME BPE	19.05	1.65
25	78.0	104.0	EN ISO 1127 / ISO 4200	33.70	2.00
	77.8	94.0	SMS 3008	25.00	1.20
	77.8	94.0	BS 4825 / ASME BPE	25.40	1.65
32	81.6	119.0	EN ISO 1127 / ISO 4200	42.40	2.00
	-	-	SMS 3008	-	-
	78.0	104.0	BS 4825 / ASME BPE	32.00	1.65
40	85.4	129.0	EN ISO 1127 / ISO 4200	48.30	2.00
	81.6	119.0	SMS 3008	38.00	1.20
	81.6	119.0	BS 4825 / ASME BPE	38.10	1.65
50	91.5	148.5	EN ISO 1127 / ISO 4200	60.30	2.60
	85.4	128.0	SMS 3008	51.00	1.20
	85.4	128.0	BS 4825 / ASME BPE	50.80	1.65
65	-	-	EN ISO 1127 / ISO 4200	-	-
	91.5	147.0	SMS 3008	63.50	1.60
	91.5	147.0	BS 4825 / ASME BPE	63.50	1.65

Clamp connection

ISO (for pipe EN ISO 1127 / ISO 4200),
SMS 3017 / ISO 2852* or BS 4825 / ASME BPE*
in stainless steel (316L - 1.4404)

* Available with internal surface finish Ra = 0.8 µm

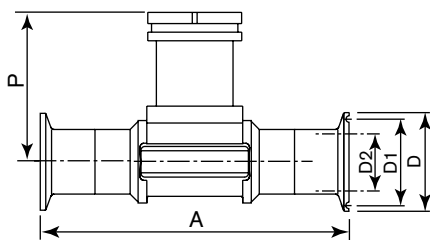

NOTE:
short sensor version

DN	P	A	Standard	D2	D1	D
[mm]	[mm]	[mm]		[mm]	[mm]	[mm]
15	80.3	130	ISO (for pipe EN ISO 1127 / ISO 4200)	18.10	27.5	34.0
	-	-	SMS 3017 / ISO 2852	-	-	-
	-	-	ASME BPE	-	-	-
20	77.8	150	ISO (for pipe EN ISO 1127 / ISO 4200)	23.70	43.5	50.5
	-	-	SMS 3017 / ISO 2852	-	-	-
	80.3	119	ASME BPE	15.75	19.6	25.0
25	78.0	160	ISO (for pipe EN ISO 1127 / ISO 4200)	29.70	43.5	50.5
	77.8	129	SMS 3017 / ISO 2852	22.60	43.5	50.5
	77.8	129	BS 4825 / ASME BPE	22.10	43.5	50.5
32	81.6	180	ISO (for pipe EN ISO 1127 / ISO 4200)	38.40	43.5	50.5
	-	-	SMS 3017 / ISO 2852	-	-	-
	-	-	BS 4825 / ASME BPE	-	-	-
40	85.4	200	ISO (for pipe EN ISO 1127 / ISO 4200)	44.30	56.5	64.0
	81.6	161	SMS 3017 / ISO 2852	35.60	43.5	50.5
	81.6	161	BS 4825 / ASME BPE	34.80	43.5	50.5
50	91.5	230	ISO (for pipe EN ISO 1127 / ISO 4200)	55.10	70.5	77.5
	85.4	192	SMS 3017 / ISO 2852	48.60	56.5	64.0
	85.4	192	BS 4825 / ASME BPE	47.50	56.5	64.0
65	-	-	ISO (for pipe EN ISO 1127 / ISO 4200)	-	-	-
	91.5	216	SMS 3017 / ISO 2852	60.30	70.5	77.5
	91.5	216	BS 4825 / ASME BPE	60.20	70.5	77.5

INSERTION fitting dimensions

Flange connection

DIN 2633 (ISO PN16), ANSI B16-5-1988 or JIS 10 K
in stainless steel (316L - 1.4404)

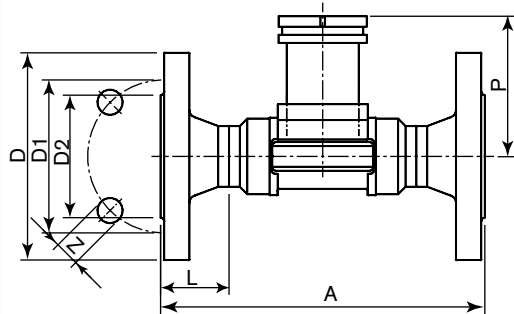
**NOTE:**

short sensor version

DN	P	A	Standard	L	Z	D2	D1	D
[mm]	[mm]	[mm]		[mm]	[mm]	[mm]	[mm]	[mm]
15	80.3	130	DIN	23.5	4x14.0	45.0	65.0	95.0
		130	ANSI					
		152	JIS					
20	77.8	150	DIN	28.5	4x14.0	58.0	75.0	105.0
		150	ANSI					
		178	JIS					
25	78.0	160	DIN	28.5	4x14.0	68.0	85.0	115.0
		160	ANSI					
		216	JIS					
32	81.6	180	DIN	31.0	4x18.0	78.0	100.0	140.0
		180	ANSI					
		229	JIS					
40	85.4	200	DIN	36.0	4x18.0	88.0	110.0	150.0
		200	ANSI					
		241	JIS					
50	91.5	230	DIN	41.0	4x18.0	102.0	125.0	165.0
		230	ANSI					
		267	JIS					

True union connection

DIN 8063, ASTM D 1785/76 or JIS K in PVC,
DIN 16962 in PP or
ISO 10931 in PVDF

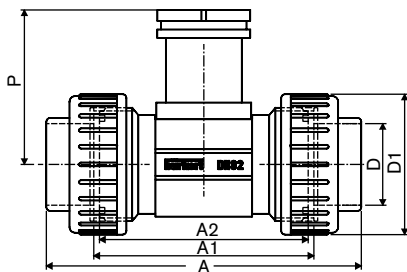
**NOTE:**

short sensor version

DN	P	A	Standard	A1	A2	D	D1
[mm]	[mm]	[mm]		[mm]	[mm]	[mm]	[mm]
15	80.4	128.0	DIN / ISO	96	90	20.00	43
		130.0	ASTM				
		129.0	JIS				
15*	81.4	148.0	DIN / ISO	116	110	20.00	74
20	77.8	144.0	DIN / ISO	106	100	25.00	53
		145.6	ASTM				
		145.0	JIS				
20*	81.4	154.0	DIN / ISO	116	110	25.00	74
25	78.0	160.0	DIN / ISO	116	110	32.00	60
		161.4	ASTM				
		161.0	JIS				
25*	81.4	160.0	DIN / ISO	116	110	32.00	74
32	81.4	168.0	DIN / ISO	116	110	40.00	74
		170.0	ASTM				
		169.0	JIS				
40	85.2	188.0	DIN / ISO	127	120	50.00	83
		190.2	ASTM				
		190.0	JIS				
50	91.5	212.0	DIN / ISO	136	130	63.00	103
		213.6	ASTM				
		213.0	JIS				

* Analysis version

INSERTION fitting dimensions

Spigot connection

DIN 8063 in PVC,
DIN 16962 in PP or
ISO 10931 in PVDF

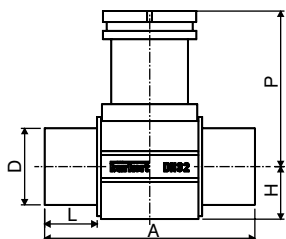

NOTE:
short sensor version

DN	P	A	Standard	L	D	H
[mm]	[mm]	[mm]		[mm]	[mm]	[mm]
15	80.4	90	DIN 8063	16.5	20	17.5
		85	DIN 16962	14.0		
		85	ISO 10931	14.0		
20	77.8	100	DIN 8063	20.0	25	17.5
		92	DIN 16962	16.0		
		92	ISO 10931	16.0		
25	78.0	110	DIN 8063	23.0	32	21.5
		95	DIN 16962	18.0		
		95	ISO 10931	18.0		
32	81.4	110	DIN 8063	27.5	40	27.5
		100	DIN 16962	20.0		
		100	ISO 10931	20.0		
40	85.2	120	DIN 8063	30.0	50	31.5
		106	DIN 16962	23.0		
		106	ISO 10931	23.0		
50	91.5	130	DIN 8063	37.0	63	39.5
		110	DIN 16962	27.0		
		110	ISO 10931	27.0		

Welding tab with radius

in stainless steel (316L - 1.4404)

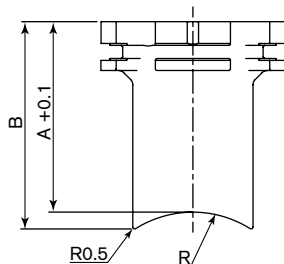

NOTE:
sensor version:
- short for DN 50 - DN 200
- long for DN 250 - DN 350

DN	A	B	R
[mm]	[mm]	[mm]	[mm]
50	56.6	61.6	30.2
65	54.5	58.6	36.7
80	53.1	56.4	44.5
100	50.7	53.2	57.2
125	48.2	50.3	70.7
150	45.7	47.4	84.2
200	41.0	42.3	109.6
250	73.6	74.7	136.6
300	67.8	68.7	162.0
350	63.9	64.7	177.8

Saddle

in PVC

Body material: PVC
Seal material: BUNA

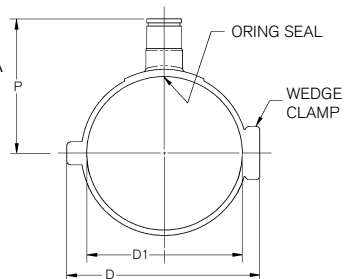

NOTE:
short sensor version required
up to 4". Long sensor version
required 6"-8"

DN	D	P	D1
[in.] (mm)	[mm]	[mm]	[mm]
2 1/2" (65)	129	115.0	75.0
3" (80)	144	119.0	90.0
4" (100)	163	107.0	114.0
6" (150)	219	168.0	168.0
8" (200)	272	191.0	218.0

INSERTION fitting dimensions

Saddle

in carbon steel

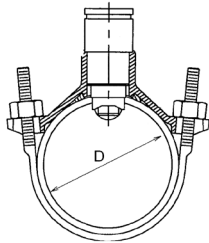

Item no.	Pipe size [inches]	D [inches]
98146031	2"	2.35 – 2.56
98146024	3"	2.97 – 3.54
98146025	4"	4.14 – 4.80
98146026	6"	5.94 – 6.90
98146027	8"	7.69 – 9.05
98146028	10"	10.64 – 12.12
98146029	12"	12.62 – 14.32
98109612	14"	14.73 – 15.65

NOTE:**Long finger only.**

Vertical mounting is recommended for best overall performance. Mount at a maximum of 45° when air bubbles are present. Do not mount on the bottom of the pipe when sediments are present.

D = I.D. of the Saddle**Weldolet**

in carbon steel

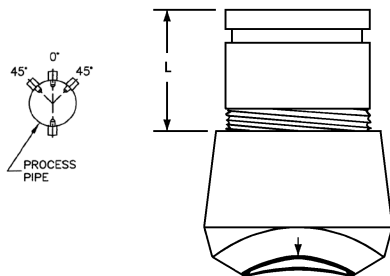

Pipe size [inches]	L [inches]
2"	2.61
2 1/2"	2.53
3"	2.47
4"	2.38
6"	2.19
8"	2.00
10"	1.80
12"	1.62
14"	1.50

NOTE:**Long finger only.**

Vertical mounting is recommended for best overall performance. Mount at a maximum of 45° when air bubbles are present. Do not mount on the bottom of the pipe when sediments are present.

INSERTION fitting dimensions

Fusion spigot
in PE, PP or PVDF

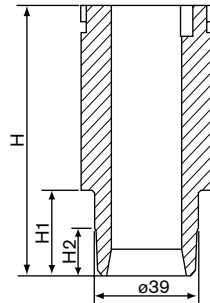

NOTE:
sensor version:
- short for DN 65 - DN 100
- long for DN 150 - DN 400

DN [mm]	H [mm]	Materials [mm]	H1 [mm]	H2 [mm]
65	72.5	PE	13.0	-
		PP	13.0	-
		PVDF	10.4	-
80	72.5	PE	15.6	-
		PP	15.6	-
		PVDF	12.5	-
100	72.5	PE	19.0	5.0
		PP	19.0	5.0
		PVDF	15.2	6
125	102.0	PE	24.2	8.0
		PP	-	-
		PVDF	-	-
150	102.0	PE	27.7	10.0
		PP	27.7	10.0
		PVDF	-	-
200	102.0	PE	38.9	16.0
		PP	38.9	16.0
		PVDF	-	-
250	102.0	PE	48.4	21.0
		PP	48.4	21.0
		PVDF	-	-
300	102.0	PE	54.5	24.0
		PP	54.5	24.0
		PVDF	-	-
350	102.0	PE	61.3	28.0
		PP	61.3	28.0
		PVDF	-	-
400	102.0	PE	69.1	31.5
		PP	-	-
		PVDF	-	-

DTS 1000082504 EN Version: E Status: RL (released | freigegeben | validé) printed: 20.01.2015

Screw-on
DN 100 to 400
in PVC, PP, PE

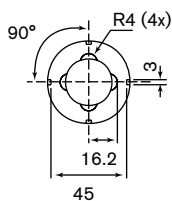
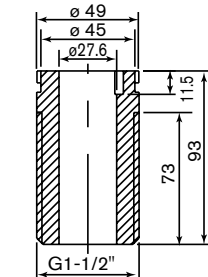

NOTE:
long sensor version

Measuring chamber (only for analysis sensor / transmitter version)

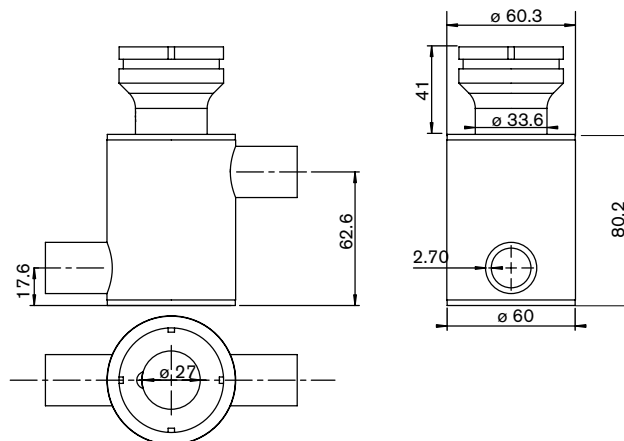

NOTE:
Materials: stainless steel 316L
Pipe connection: G 1/2"

Ordering chart for fitting S020

1/4" to 2 1/2"

Port connection	Seal	Standard	Item no. 1/4" (DN 6) ²⁾	Item no. 5/16" (DN 8) ²⁾	Item no. DN 15	Item no. DN 20	Item no. DN 25	Item no. DN 32	Item no. DN 40	Item no. DN 50	Item no. DN 65
Brass body & stainless steel adaptation part - T-fitting - Temperature max. 320°F, 232 PSI											
Internal thread	FKM	G	-	-	428 712	428 713	428 714	428 715	428 716	428 717	-
		NPT	-	-	428 718	428 719	428 720	428 721	428 722	428 723	-
		Rc (ISO7)	-	-	428 724	428 725	428 726	428 727	428 728	428 729	-
External thread	FKM	G	-	-	428 730	428 731	428 732	428 733	428 734	428 735	-
Stainless steel body & stainless steel adaptation part - T-fitting - Temperature max. 320°F, 232 PSI											
Internal thread	FKM	G	-	-	428 736	428 737	428 738	428 739	428 740	428 741	-
		NPT	-	-	428 742	428 743	428 744	428 745	428 746	428 747	-
		Rc (ISO7)	-	-	428 748	428 749	428 750	428 751	428 752	428 753	-
External thread	FKM	G	552 434	552 432	428 754	428 755	428 756	428 757	428 758	428 759	-
	EPDM	SMS 1145	-	-	-	-	443 317	-	443 318	443 319	-
Weld ends	FKM	EN ISO 1127 / ISO 4200	-	-	428 760	428 761	428 762	428 763	428 764	428 765	-
	EPDM	SMS 3008	-	-	-	-	443 309	-	443 310	443 311	443 944
		BS 4825 / ASME BPE	-	-	-	443 734 ¹⁾	443 735	443 736	443 942	443 943	443 944
Clamp	FKM	ISO (for pipe EN ISO 1127/ISO4200)	-	-	428 766	428 767	428 768	428 769	428 770	428 771	-
	EPDM	SMS 3017 / ISO 2852	-	-	-	-	443 313	-	443 314	443 315	443 969
		SMS 3017 / ISO 2852*	-	-	-	-	443 957	-	443 958	443 959	443 974
		BS 4825 / ASME BPE	-	-	-	443 965 ¹⁾	443 966	-	443 967	443 968	443 969
		BS 4825 / ASME BPE*	-	-	-	443 970	443 971	-	443 972	443 973	443 974
Flange	FKM	DIN 2633	-	-	428 772	428 773	428 774	428 775	428 776	428 777	-
		ANSI B16-5-1988	-	-	428 778	428 779	428 780	428 781	428 782	428 783	-
		JIS 10K	-	-	431 053	431 054	431 055	431 056	431 057	431 058	-
PVC & PVC adaptation part - T-fitting - Temperature max. 122°F, 145 PSI											
True union	FKM	DIN 8063	-	-	428 670	428 671	428 672	428 673	428 674	428 675	-
		ASTM D 1785/76	-	-	428 682	428 683	428 684	428 685	428 686	428 687	-
		JIS K	-	-	429 078	429 079	429 080	429 081	429 082	429 083	-
Spigot	FKM	DIN 8063	-	-	428 676	428 677	428 678	428 679	428 680	428 681	-
External thread	FKM	G	552 561	550 062	-	-	-	-	-	-	-
Analysis True union	FKM	DIN 8063	-	-	430 837	430 838	430 839	428 673	428 674	428 675	-
PP & PP adaptation part - T-fitting - Temperature max. 176°F, 145 PSI											
True union	FKM	DIN 16962	-	-	428 688	428 689	428 690	428 691	428 692	428 693	-
Spigot	FKM	DIN 16962	-	-	428 694	428 695	428 696	428 697	428 698	428 699	-
Analysis True union	FKM	DIN 16962	-	-	430 840	430 841	430 842	428 691	428 692	428 693	-
PVDF & PVDF adaptation part - T-fitting - Temperature max. 212°F, 145 PSI											
True union	FKM	ISO 10931	-	-	428 700	428 701	428 702	428 703	428 704	428 705	-
Spigot	FKM	ISO 10931	-	-	428 706	428 707	428 708	428 709	428 710	428 711	-
Analysis True union	FKM	ISO 10931	-	-	430 843	430 844	430 845	428 703	428 704	428 705	-

* internal surface finish Ra = 0.8 µm

1) DN 20 only available in ASME BPE

2) Reduced orifice with G 1/2 male threads

Ordering chart for fitting S020

2" to 16"

Port connection	Item no. 2" (DN 50)	Item no. 2 1/2" (DN 65)	Item no. 3" (DN 80)	Item no. 4" (DN 100)	Item no. 5" (DN 125)	Item no. 6" (DN 150)	Item no. 8" (DN 200)	Item no. 10" (DN 250)	Item no. 12" (DN 300)	Item no. 14" (DN 350)	Item no. 16" (DN 400)
Stainless steel - welding tab with radius - Temperature max. 320°F, 232 PSI											
Welding tabs	418 111	418 112	418 113	418 114	418 115	418 116	418 117	418 756	420 070	416 637	-
PVC - Screw-on fitting - Temperature max. 122°F, 145 PSI											
Screw-on	-	-	-	418 170	418 170	418 170	418 170	-	-	-	-
PVDF - Fusion spigot - Temperature max. 212°F, 145 PSI											
Fusion spigot	-	418 658	418 659	418 660	-	-	-	-	-	-	-
Analysis Fusion spigot	-	418 660	418 660	418 660	418 660	418 660	418 660	-	-	-	-
PE - Fusion spigot or screw-on fitting - Temperature max. 158°F, 145 PSI											
Fusion spigot	-	418 642	418 643	418 644	418 590	418 645	418 646	418 647	418 648	418 649	418 598
Screw-on	-	-	-	436 489	436 489	436 489	436 489	436 489	436 489	436 489	436 489
Analysis Fusion spigot	-	418 644	418 644	418 644	418 644	418 644	418 644	-	-	-	-
PP - Fusion spigot or screw-on fitting - Temperature max. 176°F, 145 PSI											
Fusion spigot	-	418 650	418 651	418 652	-	418 653	418 654	418 655	418 656	418 657	-
Screw-on	-	-	-	436 488	436 488	436 488	436 488	436 488	436 488	436 488	436 488
Analysis Fusion spigot	-	418 652	418 652	418 652	418 652	418 652	418 652	-	-	-	-
PVC - Saddle - BUNA seal - (long finger required for 6" & 8" saddle)											
Saddle	-	413 469	413 470	98146019	-	98146017	98146030	-	-	-	-
Carbon steel - Saddle - (requires long finger sensor)											
Saddle	98146031	-	98146024	98146025	-	98146026	98146027	98146028	98146029	98109612	-
Carbon steel - Weldolet - (requires long finger sensor)											
Weldolet	98146032	98146034	98146035	98146020	-	98146021	98146022	98146023	98146036	-	-

Ordering chart for accessories / spare parts (other versions on request)

Description	Item no.
O-ring set (DN 06 to 65)	
FKM - for metal fitting (5 units)	428 971
EPDM - for metal fitting (5 units)	428 972
FKM - for plastic fitting (1 unit)	427 423
EPDM - for plastic fitting (1 unit)	427 424
Stopper with ring, union nut and O-ring	
Stainless steel	438 755
PVC	438 754
PP	627 614
Measuring chamber	
Stainless steel ¹⁾ 316L (1.4404)	553 611

1) other material on request

Description	Item no.
Adaptation part (DN 06 to 65)	
Stainless steel	555 484
PVC	419 098
PP	419 808
PVDF	419 809
Approvals / Certificates	
3.1 certificate	440 790
2.2 certificate	440 789
Rugosity certificate	444 898
FDA approval	449 788

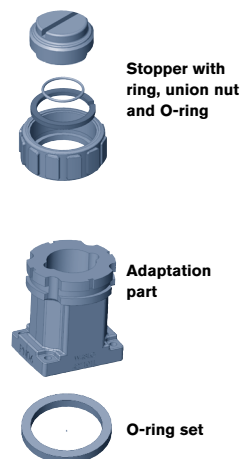

Interconnection possibilities with the S020

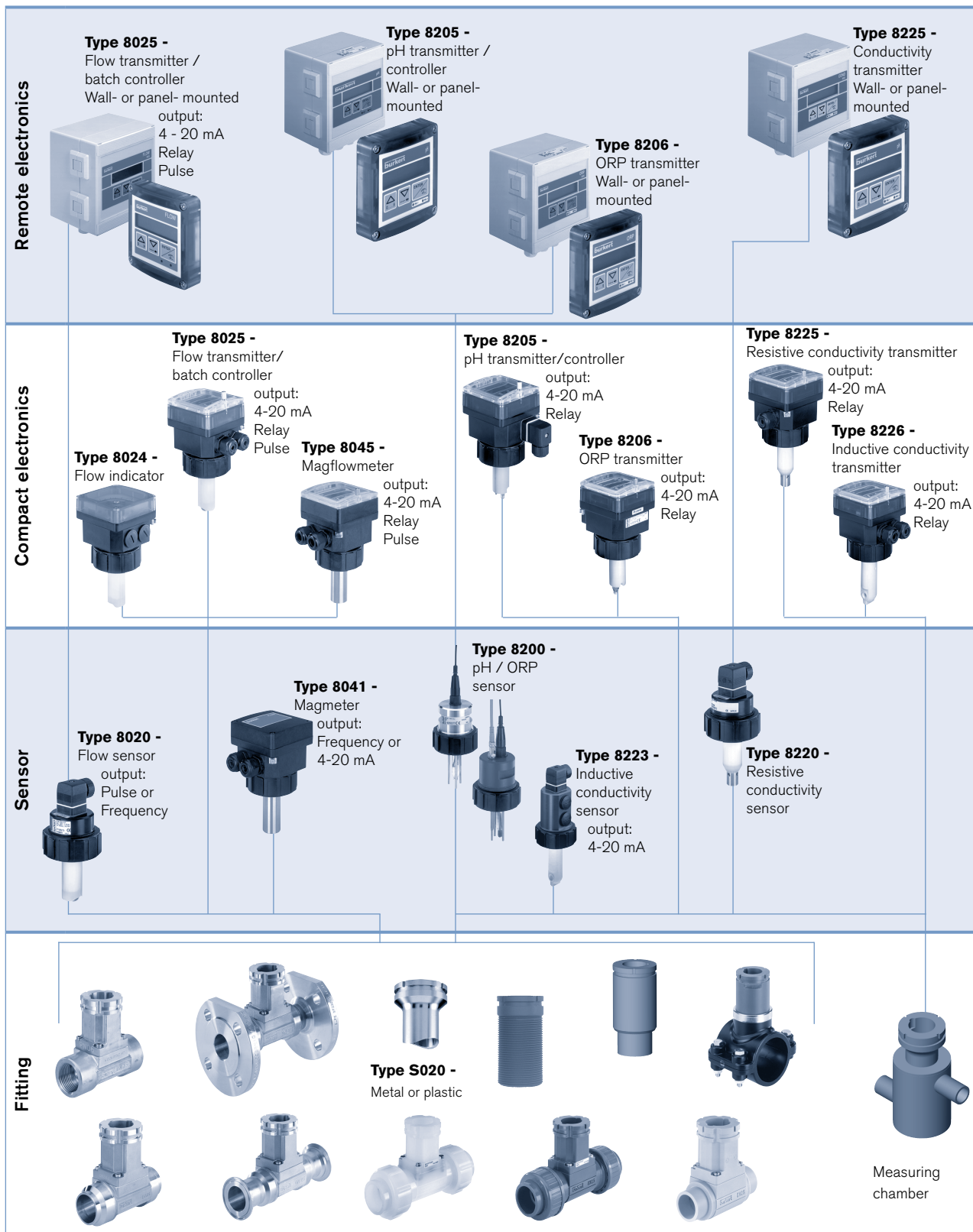

DTS 1000082504 EN Version: E Status: RL (released | freigegeben | valide) printed: 20.01.2015

To find your nearest Burkert facility, click on the orange box → www.burkert-usa.com

In case of special application conditions, please consult for advice.

We reserve the right to make technical changes without notice.

1409/2_US-en_1000082504